

## Low voltage (LV) Input/Output

**S4-34410\***  
S4 1-Input Interface Module (low voltage)

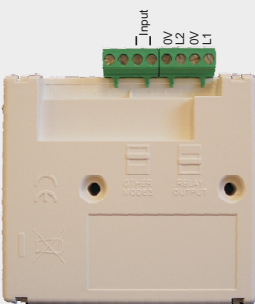

1- End-of-line Capacitor unit  
2- 10K Resistors

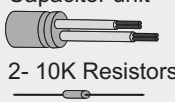

**S4-34420\***  
S4 1-Output & 1-Input Interface Module (low voltage)

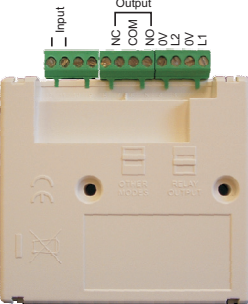

2- 10K Resistors



**S4-34450\***  
S4 4-Input / Output Interface Module (low voltage)

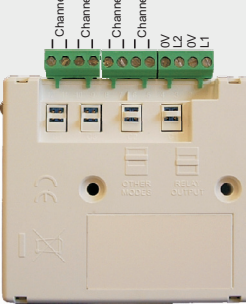

1- End-of-line Capacitor unit  
8- 10K Resistors

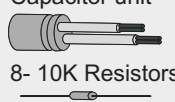

**S4-34490\***  
Plastic box



1- Allen key  
2- M4 Screws  
2- M4 Posi Pan Screws  
7- Hole plugs

**S4-34492\***  
Metal box



**S4-34491**  
DIN rail mount bracket



\* - LPCB approved



These instructions cover the above LPCB approved interface modules and accessories. These interface modules are designed for use with Vigilon and 34000 fire alarm control panel. Each module includes a loop isolator for device isolation. Each interface module use one of 207 available device addresses on a loop and responds to regular polls from the control panel reporting the type of device and the status (open/normal/short) of its supervised input circuit(s).

### Features

- Analogue addressable communications
- Built-in type identification automatically identifies these devices to the control panel
- Reliable communication technique with high noise immunity
- Soft or SAFE addressing
- Common mounting options including surface mount, panel mount and DIN rail mount
- Dual-colour LEDs
- Plug-in terminal connections for ease of wiring
- EN54-17:2005 and EN54-18:2005

### Cables

The cables recommended for wiring the input / output lines are the same as those used for loop wiring, see instructions supplied with the fire control panel.

### Installation

The S4 interface modules can be mounted in other equipment housings using the DIN rail mount brackets (S4-34491). A module can also be fitted into a plastic box (S4-34490) or metal box (S4-34492). The boxes have cable termination points on the enclosure for incoming cables.

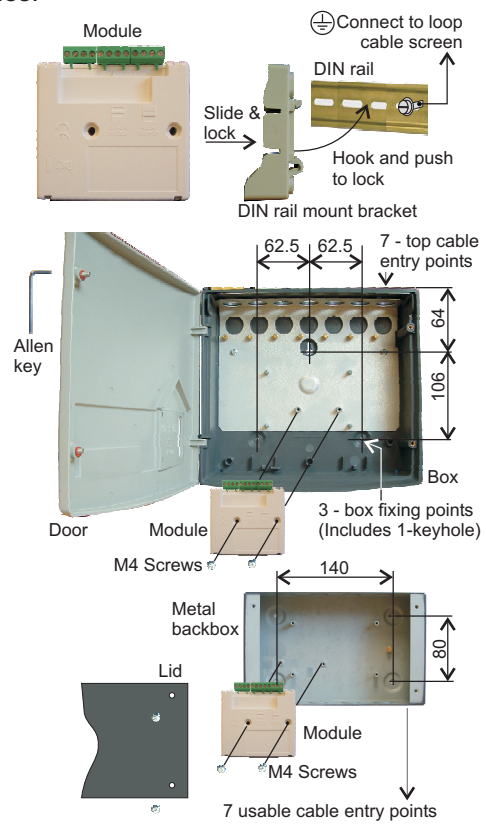

**Maximum cable usage per circuit**



**Cable usage per circuit of:**

- Zone circuit - 100 metres maximum
- Clean contact Input circuit - 300 metres maximum
- LED output - 30 metres maximum
- Relay output - unlimited.

**End-of-line (EOL) devices**

- An input circuit require in series with the contacts a 10K resistor plus a 10K EOL resistor (supplied).
- A zone input circuit is monitored with an EOL capacitor unit (supplied).

**Zone input functionality**

A zone input can have conventional detectors and manual call points (MCPs) connected. All MCPs must have a 470 Ohms or 3V9 zener diode in series with normally open contacts. The zone input can take a maximum load of up to 2mA at 24V nominal (with minimum operating voltage of 18V). The zone circuit must be terminated with an EOL capacitor unit.

**Confirmation Input / Output functionality**

An input and an output of a module can be paired to operate in a confirmation mode. External equipment can send an acknowledgement upon receiving a signal from the module, this is called 'confirmation input'. External equipment can also receive an acknowledgement from the module upon sending it a signal, this is called 'confirmation output'.

**S4 1-Input Interface**

The single input interface module monitors a circuit of either normally open or closed contacts. The input can be programmed as a fire, fault, supervisory or confirmation input. Optionally it is also possible to configure the input for a zone of conventional detectors and MCPs. In all input modes the interface will detect short and open circuit faults.

**S4 4-Input /Output Interface**

The quad input/output interface module can be configured to provide any combination of up to four inputs or outputs. An output of either normally open or normally closed relay contacts can be used to control a load of up to 1A @ 30Vdc/ac. Optionally an output can be configured to provide 1.5mA at 24V dc to drive an LED that can be normally On or normally Off. An input can be programmed as a fire, fault, supervisory or confirmation input. Additionally it is possible for channel 1 to be used as a Zone input, which allow connection of conventional detectors and MCPs to this module. Zone input can be configured to have alarm validation feature and configurable reset time. The alarm validation feature can be used

to minimise false alarms by suppressing a fire input for a period of time defined during commissioning. The zone reset period can be extended to allow for different types of fire detectors.

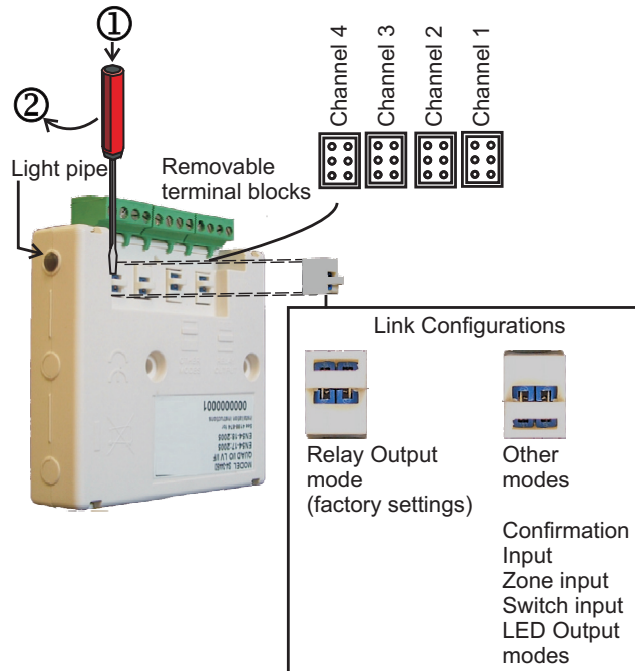

Configure the links to the required mode.

**S4 1-Output & 1-Input Interface**

This interface module can be used to control a resistive load of up to 1A @ 30Vdc/ac via a set of single pole change over contacts, see wiring diagrams. In addition there is an input to allow the monitoring of the external equipment. In this application the input must be configured as a confirmation input. A confirmation input generates a fault if a change of state is not seen within the predefined period of a specific output.

**Configuration**



**Use the Commissioning Tool Version 1.21 or greater to commission these interface modules.**

**Wiring diagrams**



The loop cable screen must be continued through each interface module. The loop, switch input, zone input and LED output cable screens where used must connect to an earth terminal.

**S4 1-Input module connection details**

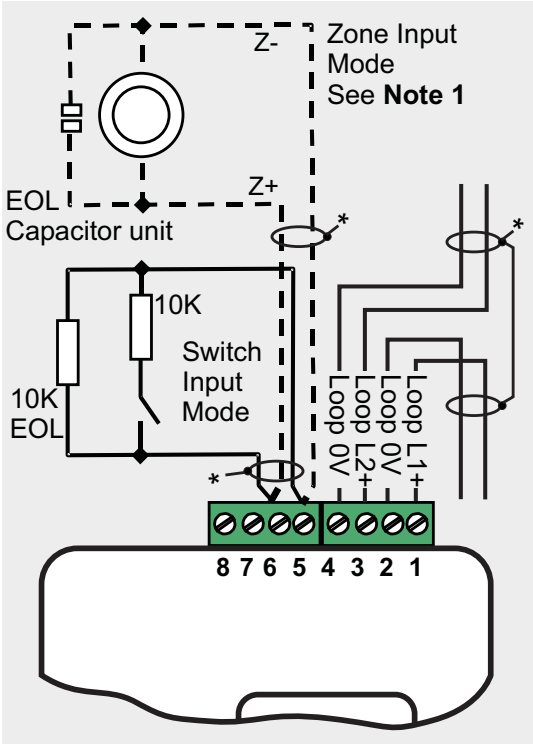

**S4 4-Input/Output module connection details**

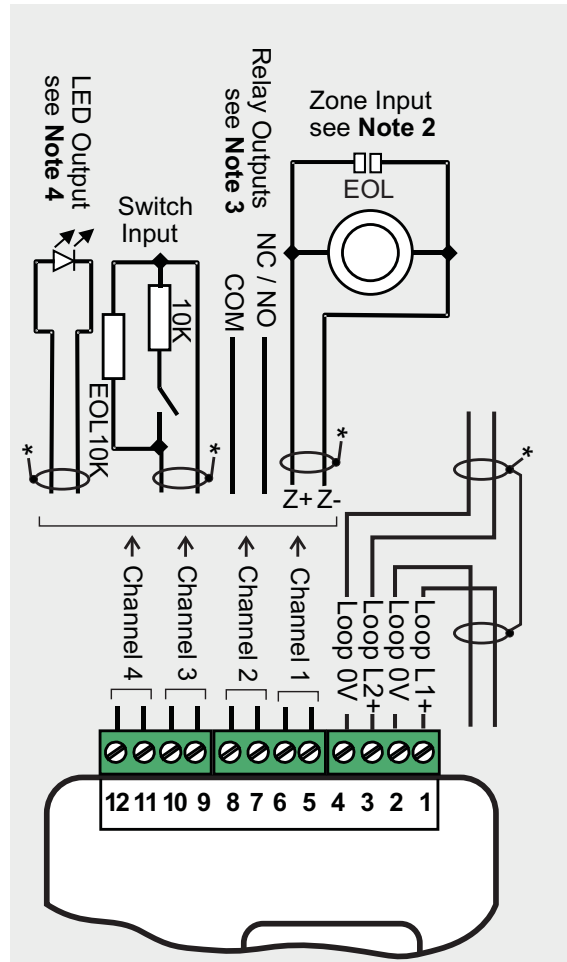

**S4 1-Output & 1-input module connection details**

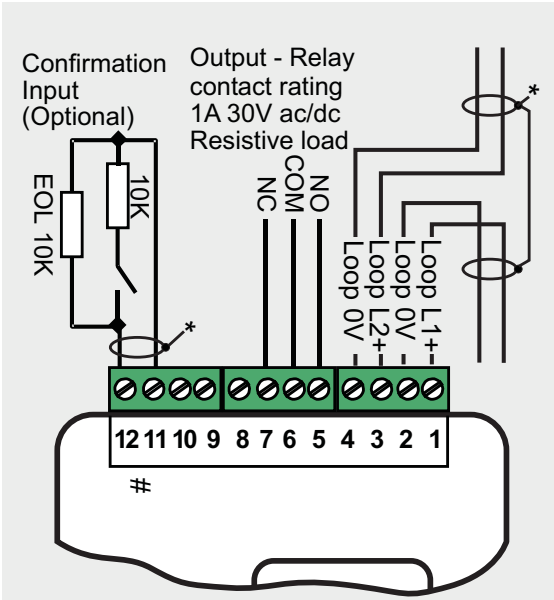

Note 1 - When the input is configured as a Zone input it is possible to attach conventional detectors and MCPs (with 470 Ohms or 3V9 zener diode in series with normally open contacts), maximum load is 2mA @ 24V nominal (18V minimum) with End-of-line capacitor.

Note 2 - Only channel 1 (terminals 5 & 6) can be configured as an zone input.

Note 3 - Contact rating 1A 30V ac/dc Resistive load.

Note 4 - Output is 1.5mA @ 24V dc.

# Can be configured as LED output

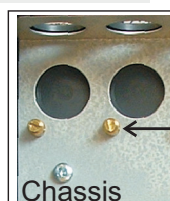

\* The cable screens must be connected to an **earth terminal** on the chassis or in the metal box.

← If a module is mounted on a **DIN rail** then the DIN rail must electrically connected to the **loop cable screen via the earth terminal**.

**Technical data**

	<b>S4-34410</b> S4 1- Input	<b>S4-34450</b> S4 4-Input /Output	<b>S4-34420</b> S4 1-Output & 1-Input						
LPCB Approved	EN54-17:2005 and EN54-18:2005								
Weight-dimen. module	92g ①	100g ①	100g ①						
module in plastic box	1047g ②	1055g ②	1055g ②						
module in metal box	782g③	790g ③	790g ③						
Storage temperature	-30°C to 70°C								
Operating temperature	-10°C to 60°C								
Relative Humidity	Up to 95% - Temperature 5°C to 45°C (Non condensing)								
Emission	BS EN 61000-6-3:2001 Residential, Commercial & Light Industry <b>Class B limits</b>								
Immunity	BS EN50130-4: 1996: Part 4								
LVD	BS EN 60950-2002								
Ingress Protection	IP31 for plastic box S4-34490 & IP40 estimated for metal box S4-34492								
Colour	Module-white / Plastic box-dark grey (Lid-light grey) / Metal box-dark grey								
Input mode	Input channel-1 only can be configured as a zone input to accept conventional devices, with a load of 2mA quiescent and 9mA alarm maximum at 24V nominal (18V minimum). With configurable 2s to 5s reset period and 5s to 40s alarm validation delay.								
Switch input can work with or without a delay.	Input channel can be configured as a <b>switch input</b> of Fire*, Fault*, Supervisory* (non fire) or Confirmation# signal. * with input acceptance delay of up to 10 seconds for a Fire input and up to 300s for Fault or Supervisory input. # A fault is generated if confirmation input is not seen within predefined period of the output action (Confirmation function is not a feature of the single input module).								
Output mode	-	A relay output of either NO or NC set of contacts rated 1A - 30Vac/dc resistive load.	A relay output of change over contacts NC, COM and NO rated 1A - 30Vac/dc resistive load.						
LED output	1.5mA at 24Vdc (Normally On or Normally Off)								
Load Factor	1-4 switch inputs = <b>1</b> (maximum 200 per loop) 1-4 relay outputs = <b>2</b> (maximum 200 per loop only 8 individually sectored) Zone Input = <b>26</b> (maximum 30 per loop) Every LED output = <b>+5</b> (maximum 100 LED outputs per loop)								
EN54-17 data	<b>V<sub>max</sub></b> <b>42V</b>	<b>V<sub>nom</sub></b> 40V	<b>V<sub>min</sub></b> <b>24V</b>	<b>V<sub>SO max</sub></b> 16V	<b>V<sub>SO min</sub></b> <b>8V</b>	<b>I<sub>C max</sub></b> 0.4A	<b>I<sub>S max</sub></b> <b>1A</b>	<b>I<sub>L max</sub></b> 20µA	<b>Z<sub>C max</sub></b> <b>0.10Ω</b>
Panel compatibility	Fully compatible with LPC = V3.93 / V4.35 & MCC/MCB = V3.94 / V4.37. For further information on upgrade requirements contact Gent by Honeywell								

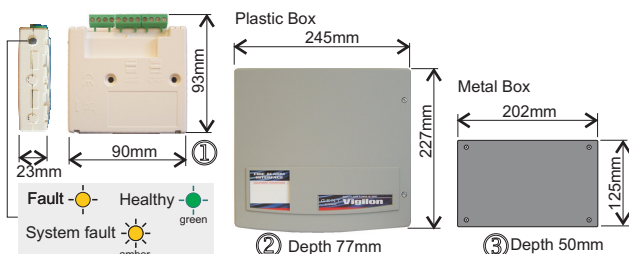

**CE**  
0832  
Gent by Honeywell  
Hamilton Industrial Park,  
140 Waterside Road,  
Leicester LE5 1TN, UK

Product No.	EC Certification of Conformity No.
S4-34410	0832-CPD-1403
S4-34420	0832-CPD-1409
S4-34450	0832-CPD-1411

**At the end of their useful life, the packaging, product and batteries should be disposed of via a suitable recycling centre and in accordance with national or local legislation.**

**WEEE Directive:**  
At the end of their useful life, the packaging, product and batteries should be disposed of via a suitable recycling centre. Do not dispose of with your normal household waste. Do not burn.

Gent by Honeywell reserves the right to revise this publication from time to time and make changes to the content hereof without obligation to notify any person of such revisions of changes.

<b>GENT</b> by Honeywell	Hamilton Industrial Park, Waterside Road, Leicester LE5 1TN, UK		Website: <a href="http://www.gent.co.uk">www.gent.co.uk</a>
	Telephone: +44 (0) 116 246 2000	Technical support: <a href="http://www.gentexpert.co.uk">www.gentexpert.co.uk</a>	Fax (UK): +44 (0)116 246 2300

# Commissioning information

## Interface Modules for Vigilon

### Low Voltage (LV) Input/Output



This leaflet covers commissioning information for:

- S4-34410 1-Input Interface Module
- S4-34420 1-Output & 1-Input Interface Module
- S4-34450 4-Input/Output Interface Module

### Full Compatibility

The S4 Interface modules are **fully** compatible for use in Vigilon and 34000 systems where the panel is fitted with MCC/MCB and LPC cards having the following firmware:

- MCC/MCB - version 3.94 / 4.37
- LPC - version 3.93 / 4.35

For further information on upgrade requirements contact Gent by Honeywell.

### Links on S4-34450

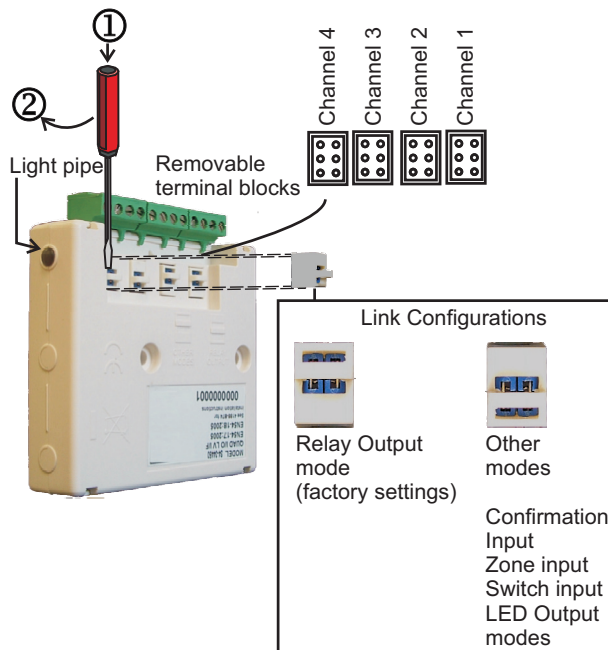

### Configuration

The S4 interface modules can only be configured with Commissioning tool software version 1.21.

The commissioning tool version 1.21 has a new icon and menu option to allow configuration of the S4 I/O Interface Modules.

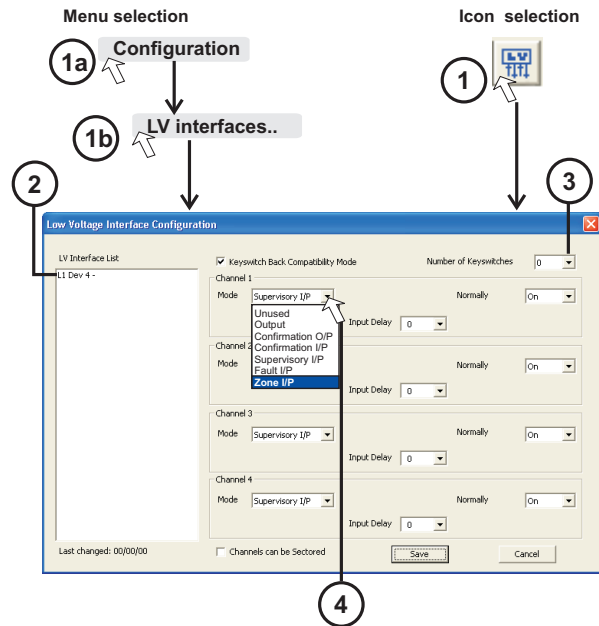

- 1) Click **Configuration** on the menu bar and select **LV Interface** or alternatively click the **LV** icon on the tool bar.
- 2) Select the required interface to be configured from the list box.
- 3) Ensure the 'Number of keyswitches' option is set to '0', because this feature is for future use.

**i** Ensure only the applicable channel is configured when configuring the S4-34415 or S4-34420 type interfaces.

- 4) Select a mode from the drop down menu. All applicable channels must be set, see next page for details.
- 5) If required check the sectored box.
- 6) Configure other LV interface modules and save the configuration.

**Channel modes**

**Unused**

This option sets the channel as not used.

**Output**

This option sets the channel for either relay or LED output. As a relay output it provides a set of normally open or normally closed contacts. As an LED output it can be set to normally On (lit) or normally Off (not lit) drive for an LED load.

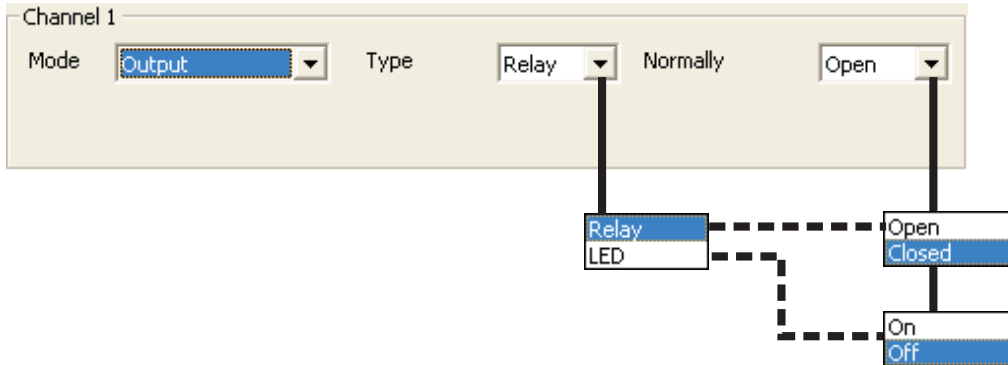

**Supervisory I/P**

This option sets the channel as a 'non fire' Supervisory input for general switching. The acceptance of the input signal can be delayed until it has remained active for a set period of time.



Settings for Supervisory, Fault and Fire inputs are similar.

The input can be either be a normally open or normally closed input.

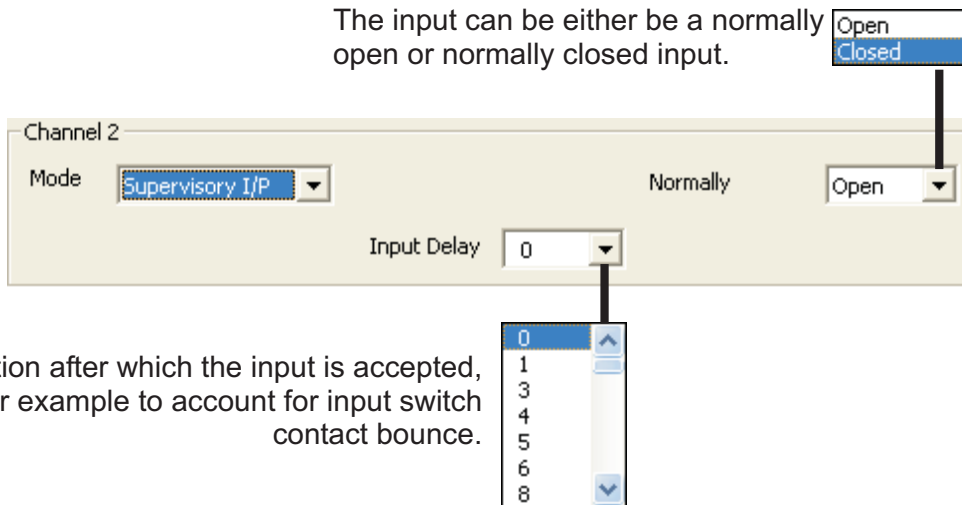

A delay duration after which the input is accepted, for example to account for input switch contact bounce.

**Fault I/P**

This option sets the channel as a fault input. The acceptance of the input signal can be delayed until it has remained active for a set period of time.

**Fire I/P**

This option sets the channel as a fire input. The acceptance of the input signal can be delayed until it has remained active for a set period of time.

**Zone I/P**



The Zone I/P is only applicable for Channel 1.

This option sets the channel to accept the connection of conventional fire detectors and manual call points.

Channel 1

Mode: Zone I/P

Validation: 0

Reset Period: 0.0

A duration after which the input is accepted.

Extendable reset duration with a default value of 2s plus this value.

**Confirmation O/P**

This option sets two channels, one as an input and another as a confirmation output. This facility allows external equipment to monitor the fire alarm system.

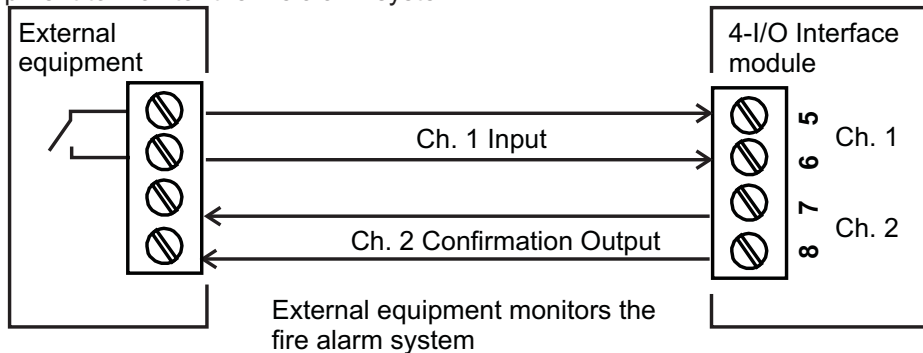

The confirmation output will operate within 1s of the input being accepted (design must also allow for any input delay settings).

Channel 1

Mode: Confirmation O/P

Type: Relay

Normally: Open

Assoc. Input: 2

Relay

LED

Open

Closed

On

Off



The associated **Input** channel cannot be the same channel as the **Confirmation O/P** channel.

**Confirmation I/P**

This option sets two channels, one as an output and another as a confirmation input. Here the fire alarm system monitors the external equipment. The confirmation input can be configured such that it can be received within a predefined time called 'confirmation time'.

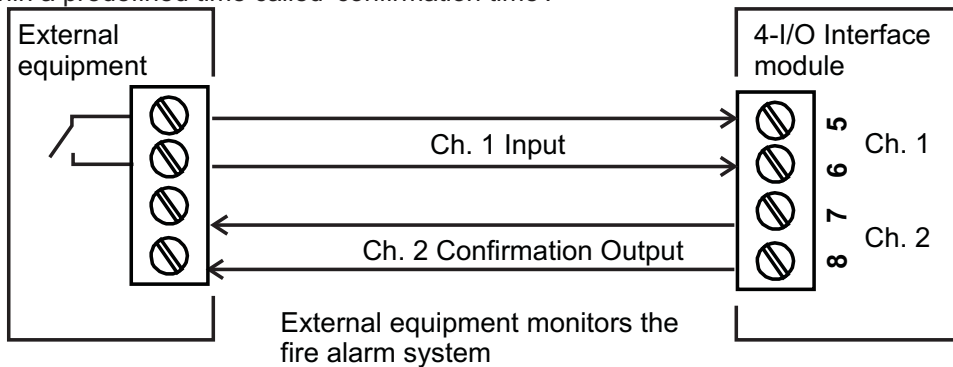

The acceptance of an active input signal can be delayed until it has remained active for a set period of time. Additionally a verbose / silent (non verbose) setting is available. The verbose setting allows supervisory message indication on change of input state and a timeout fault, given if a change of state has not occurred within the confirmation time duration. The silent setting will only give a timeout fault. This facility allows the fire alarm system to monitor external equipment.

The associated **output** channel cannot be the same channel as confirmation input channel.

The validation delay takes account of contact bounce.

The confirmation delay is the time by which a confirmation must be given.

**Keyswitch mode**

This feature is a future option.

Gent by Honeywell reserves the right to revise this publication from time to time and make changes to the content hereof without obligation to notify any person of such revisions of changes.

<b>GENT</b> by Honeywell	Hamilton Industrial Park, Waterside Road, Leicester LE5 1TN, UK	Website: <a href="http://www.gent.co.uk">www.gent.co.uk</a>
	Telephone +44 (0) 116 246 2000	Fax (UK): +44 (0)116 246 2300